

Operating Instructions

BRINKMANN Immersion Pumps

SFL550...1150



BRINKMANN PUMPS, Inc.

47060 Cartier Drive
Wixom, MI 48393
USA

Phone: +1 248 926 9400
Fax.: +1 248 926 9405

www.brinkmannpumps.com
sales@brinkmannpumps.com

Subject to change without prior notice.

Order - No.: BAS6520 ENGLISH

Brinkmann Immersions Pumps of the Series SFL550...1150

Contents

1	Indication to the manual	2	8	Servicing and Maintenance	7
2	Description of the Product	2-3	9	Troubleshooting Guide	7
3	Safety instructions	4	10	Spare Parts.....	8-9
4	Transportation and Storage.....	4	11	Repair.....	9
5	Installation and Connection	5-6	12	Disposal.....	9
6	Start-up / Shut-down	6	13	Terms and Conditions	10-11
7	Operation.....	6			

1 Indication to the manual

This operating manual gives basic instructions which are to be observed during installation, operation and maintenance of the pump. It is therefore imperative that this manual be read by the responsible personnel and operator prior to assembly and commissioning. It is always to be kept available at the installation site.

1.1 Identification of safety instructions in the operating manual

Safety instructions given in this manual non-compliance with which would affect **safety** are identified by the following symbol



Safety sign according with ISO 3864 – B.3.1

or where **electrical safety** is involved, with:



Safety sign according with ISO 3864 – B.3.6

Where non-compliance with the safety instructions may cause a risk to the machine and it's function the word

ATTENTION

is inserted.

2 Description of the Product

2.1 General description of the pump

Pumps of this type are one-stage rotary pumps where the impellers are fixed on the driving shaft extension. The pump shaft and motor shaft are interconnected by means of a shaft clamp. Pump and motor form a compact and space-saving unit. These pumps are fitted out with semi-open impellers and a suction screw.

Vertically mounted pumps are equipped with a mounting flange. The pump end immerses into the tank and the motor extends vertically above the tank.

2.2 Intended use

The immersion pumps of the series SFL are suitable for handling contaminated coolants within the limiting application in accordance with table 1.

The pumps of SFL are suitable for handling extremely inflated fluids.

Limit of Application (Table 1)

Type	SFL
Mediums	Coolant, cooling- and cutting-oils
Chip material	Aluminium, steel, coloured steels max. chip to coolant ratio by weight: 1.0%
Kinetic viscosity of the medium	...200 SSU (...45 mm ² /s)
Temperature of medium	30 ... 175 °F (0 ... 80 °C)
Particle-size in the medium	0.47 Inches (12 mm) SFL550 0.35 Inches (9 mm) SFL650 0.67 Inches (17 mm) SFL850, 860 0.63 Inches (16 mm) SFL1150
min. delivery volume	1% of Q max.
Dry running	Dry running causes increased wear and should be avoided. During the test of the direction of rotation (< 30 s) permissible.
Motor cycle time per hour	The pump SFL should be operated in continual operation mode, not pulsed mode.
Ambient temperature	104 °F (40 °C)
Set-up altitude	3280 ft (1000 m)

ATTENTION

The pumps are to be operated within their design limits. Applications outside of these limits are not approved. The manufacturer is not responsible for any damages resulting from use of the pumps in such applications.

2.3 Technical data

Type	Max. del. pressure spec. weight 1		Max. del. volume		Height		Depth of immersion		Weight		Power	
	PSI	bar	GPM	l/min	H Inches	mm	h Inches	mm	lbs	kg	HP	kW
SFL550S	13	0.85	100	390	13.1	334	5.91	150	113	23	1.4	1.06
230							9.06	230	119	24		
300							11.81	300	126	25		
..380							14.96	380	137	27		
470							18.50	470	161	28		
580							22.83	580	168	30		
SFL650S	22	1.5	180	710	18.3	464	8.66	220	113	51	3.4	2.55
320							12.60	320	119	54		
450							17.72	450	126	57		
570							22.44	570	137	62		
770							30.31	770	161	73		
1000							39.37	1000	168	76		
SFL850S	28	2.0	285	1100	18.3	464	9.06	230	115	52	3.9	2.94
330							12.99	330	121	55		
460							18.11	460	128	58		
580							22.83	580	143	65		
780							30.71	780	165	75		
1010							39.76	1010	172	78		
SFL860S	40	2.8	320	1200	19.8	503	9.06	230	141	64	6.1	4.55
330							12.99	330	148	67		
460							18.11	460	154	70		
580							22.83	580	170	77		
780							30.71	780	192	87		
1010							39.76	1010	198	90		
SFL1150S	34	2.4	350	1400	19.8	503	9.06	230	137	62	6.1	4.55
330							12.99	330	146	66		
460							18.11	460	161	73		
580							22.83	580	168	76		
780							30.71	780	187	85		
1010							39.76	1010	194	88		

The motor is surface-cooled and compliant with DIN IEC 34 and EN 60034 (protection degree IP 55).

3 Safety instructions

When operating the pump, the safety instructions contained in this manual, the relevant national accident prevention regulations and any other service and safety instructions issued by the plant operator are to be observed.

3.1 Hazards in the event of non-compliance with the safety instructions

Non-compliance with the safety instructions may produce a risk to the personnel as well as to the environment and the machine and results in a loss of any right to claim damages.

For example, non-compliance may involve the following hazards:

- Failure of important functions of the machines/plant
- Failure of specified procedures of maintenance and repair
- Exposure of people to electrical, mechanical and chemical hazards
- Endangering the environment due to hazardous substances being released

3.2 Unauthorized modes of operation



- Pump may not be used in potentially explosive environments!
- Pump and discharge piping are not designed to hold any weight and may not be used as a step ladder.

3.3 Remaining Risk



Risk of Injury!

Risk of squeezing or crushing body parts when installing or removing the pump exists. Proper and secured lifting tools must be used.

Risk of burns!

The pump must have cooled down sufficiently prior to commencing any repair, maintenance or installation.

3.4 Qualification and training of operating personnel

The personnel responsible for operation, maintenance, inspection and assembly must be adequately qualified. Scope of responsibility and supervision of the personnel must be exactly defined by the plant operator. If the staff does not have the necessary knowledge, they must be trained and instructed, which may be performed by the machine manufacturer or supplier on behalf of the plant operator. Moreover, the plant operator is to make sure that the contents of the operating manual are fully understood by the personnel.

3.5 Safety instructions relevant for operation

- If hot or cold machine components involve hazards, they must be guarded against accidental contact.
- Guards for moving parts (e.g. coupling) must not be removed from the machine while in operation.
- Any leakage of hazardous (e.g. explosive, toxic, hot) fluids (e.g. from the shaft seal) must be drained away so as to prevent any risk to persons or the environment. Statutory regulations are to be complied with.
- Hazards resulting from electricity are to be prevented (see for example, the VDE Specifications and the bye-laws of the local power supply utilities).
- The pumps' stability against falling over is not ensured unless it is properly mounted onto the tank.
- The female threads on the motor **MUST NOT** be used to lift the entire pump and motor assembly.

3.6 Safety instructions relevant for maintenance, inspection and assembly work

Any work on the machine shall only be performed when it is at a standstill, it being imperative that the procedure for shutting down the machine described in this manual be followed.

Pumps and pump units which convey hazardous media must be decontaminated.

On completion of work all safety and protective facilities must be re-installed and made operative again. Prior to restarting the machine, the instructions listed under "Start up" are to be observed.

3.7 Signs on the pump

It is imperative that signs affixed to the machine, e.g.:

- arrow indicating the direction of rotation
 - symbols indicating fluid connections
- be observed and kept legible.

3.8 Unauthorized alterations and production of spare parts

Any modification may be made to the machine only after consultation with the manufacturer. Using spare parts and accessories authorized by the manufacturer is in the interest of safety. Use of other parts may exempt the manufacturer from any liability.

4 Transportation and Storage

Protect the pump against damage when transporting. The pumps may only be transported in a horizontal position and hooks or straps must be attached on the motor and pump end.

Do not use the pump shaft for connecting any transportation aids such as hooks or straps.

Pumps must be drained prior to their storage.

Store pump in dry and protected areas and protect it against penetration of foreign bodies.

Always store pump above the freezing point!

5 Installation and Connection

5.1 Mechanical installation

During any assembly or disassembly process the pumps must be secured against tipping through ropes for example at all times.

Pumps must be mounted securely. Piping, tank and pumps must be mounted without any tension.

The inlet is at the bottom of the immersed pump body. The distance between the inlet and the tank bottom must be so large that the inlet can not be blocked by deposits during longer shutdowns.

To obtain the full flow rate it is recommended to choose for the pipework the nominal bore diameter of the pumps cross section for connection. Therefore pipe bends should be used, not pipe angles!

The pipework must be qualified for occurring hydraulic pressure.

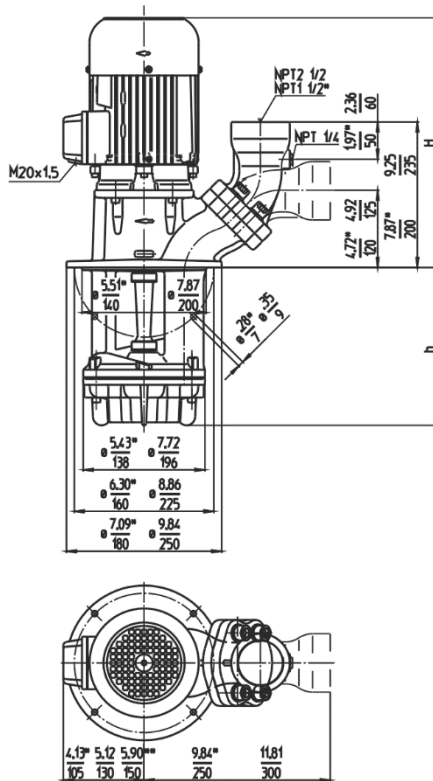

ATTENTION

Maximum tightening torque for piping connections is 110 ft. lbs. (150 Nm) for NPT 1 1/2 and 150 ft. lbs. (200 Nm) for NPT 2 1/2 !

When installed the space around the pump must be large enough to provide sufficient cooling of the motor.

Do not prop up the pressure line via the joining socket.



The pump must be mounted in that way that rotating parts under the cover of the coolant tank can not be touched!

5.2 Electric wiring



All service work must be carried out by qualified service personnel. Pump must be disconnected from the power source and all rotating parts must stand still. Reassure that pump is disconnected from power source and cannot be switched on. Verify that there is no voltage at the terminal board!

According to the European Standard EN809 a motor overload must be installed and properly set to the full load amps stated on the pump name plate.

It is the responsibility of the machine operator to decide whether or not an additional emergency switch must be installed.



Danger!

Risk of electric shock

Our asynchronous motors can optionally be fitted with temperature sensors in the form of triplet PTC thermistors, which are used for thermal monitoring of the motor windings. Please note that the temperature sensors meet the insulation requirements of basic insulation. The improper connection of the triplet PTC thermistors to evaluation units that do not have a protective function against overvoltage in the event of a fault can lead to voltages dangerous to the touch and electric shock.

Please check whether the evaluation units you intend to use are permissible for the electrical connection of the temperature sensors.

5.2.1 Circuit



Tension voltage and frequency must correspond with the shown specification on the nameplate.

The pump must be wired so that a solid longterm electrical connection is ensured. Establish a solid ground connection.

The electrical wiring must be performed according to the wiring diagram shown inside the terminal box cover. (Please see above sample wiring diagrams)

Wiring diagram e.g.

Voltage changing 1:2 YY / Y
e.g. 230 / 460 V, 60 Hz

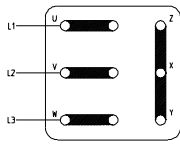

YY
Low Voltage

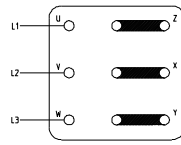

Y
High Voltage

Circuit on request

Y (Star connection)
up to 7.4 HP
(5.5 kW)

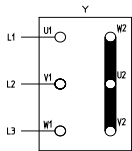

Y 440 V – 480 V
60 Hz

Δ (Delta connection)
8, 8.7, 10.1, 12.1, 14.7, 17.4 HP
(6, 6.5, 7.5, 9, 11, 13 kW)

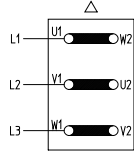

Δ 440 V – 480 V
60 Hz

Voltage changing Δ / Y.

e. g. 220 V – 240 V / 380 V – 420 V, 50 Hz

Δ (Delta Connection)

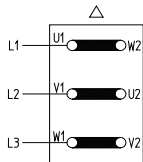

Δ 220 V – 240 V,
50 Hz

Y (Star Connection)

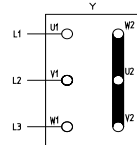

Y 380 V – 420 V,
50 Hz

There may be no foreign objects such as dirt, particles or humidity inside the terminal board.

Mount terminal board cover to motor tight against dust and humidity and close up all unused wiring ports.

ATTENTION

When Variable Frequency Drives are used interfering signals might occur.

Non-sinus shaped supply voltage from a variable frequency drive might result in elevated motor temperatures.

6 Start-up / Shut-down

6.1 Start-up

ATTENTION

Switch off at the mains.

After connection the electrical wires, close the terminal box. Briefly start the motor (max. 30 sec.) and check the rotation according to the arrow on the top of the motor.

If the direction is incorrect change over two of the power leads.

6.2 Shut-down

All service work must be carried out by qualified service personnel. Pump must be disconnected from the power source and all rotating parts must stand still. Reassure that pump is disconnected from power source and cannot be switched on. Verify that there is no voltage at the terminal board!

Open terminal box and disconnect the power leads. Empty out the pump.

7 Operation

Liquid level

According to the drawing shown below, the maximum liquid level must stay about 1.18 Inches (30 mm) below the mounting flange. Also ensure that the suction hole of pump body must be covered with liquid before starting up the motor.

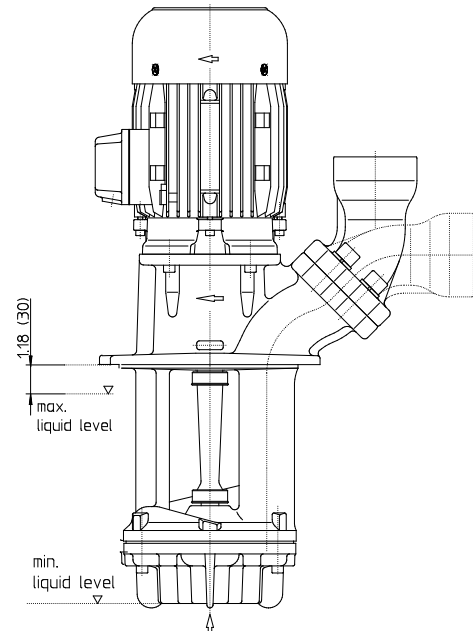

Dimensions in Inches (mm)

ATTENTION

The SFL pump should be operated in continual operation mode, not pulsed mode!

Pulsed mode causes increased wear due to the return flow of chips and additional load on the bearings.

The pump should transport medium without chips for 1-2 minutes before being switched off!



If the pump should lock up and cease, shut pump down (see 6.2) and disconnect from power supply. Pump must be uninstalled and removed from the system prior to its repair.

8 Servicing and Maintenance

ATTENTION

The surface of the motor must be kept free of dirt.
 The motor shaft is spinning in permanently greased ball bearings (with special grease and increased bearing play) and does not require any special maintenance.

9 Troubleshooting Guide

Fault	Cause	Remedy
Motor does not start, no motor noise	At least two of the power supply leads have failed	Check fuses, terminals and supply leads .
	Overload has tripped	Inspect overload
Motor does not start, humming noise	One of the supply leads has failed	See above
	Impeller faulty Motor bearing faulty	Replace impeller Replace bearing
Overload trips	Pump locked up mechanically	Inspect pump hydraulics
	High on/of cycling frequency	Check application
Power consumption is too high	Wrong direction of rotation of impeller	See above
	Lime or other deposits mechanical friction	Clean pump mechanism repair pump
Motor overheats	High on/off cycling frequency	See above
	Wrong power supply (voltage or cycles)	Power supply must correspond with name plate rating
Pump does not pump	Insufficient cooling	Check air flow at motor fan
	liquid level too low Pump mechanism faulty Pipe blocked	Fill up liquid replace pump mechanism Clean pipe
Insufficient flow and pressure	Wrong direction of rotation of impeller	Change over two power supply leads
	Pump mechanism silted up Worn pump mechanism	Clean pump mechanism Replace pump mechanism
Incorrect flow or pressure	Wrong power supply (voltage or cycles)	Power supply must correspond with name plate rating
Running noise/Vibration	Foreign objects in pump end	Remove foreign objects
	Impeller damaged	Replace impeller
	Bearing/Bushing broken	Replace bearing/bushing

10 Spare Parts

10.1 Spare Part List for the Immersion Pumps of the Series SFL550...1150

Item	Description	
1	Stator with terminal board	
2	Motor flange	
3	End shield	
4	Terminal box	
7	Fan	
8	Fan cover	
9	Ball bearing 3.4...3.9 HP (2.55...2.94 kW)	DIN 628
9	Ball bearing	DIN 625
10	Ball bearing	DIN 625
11	Gasket	
13	Retaining ring 3.4...3.9 HP (2.55...2.94 kW)	DIN 471
13	Retaining ring	
14	Thread rolling screw	DIN 7500
15	Slotted cheese head screw	DIN 84
16	Socket head cap screw	DIN 912
17	Socket head cap screw	DIN 912
18	Stud bolt with bond 1.4 HP (1.06 kW)	
19	Parallel pin	DIN 7
20	Shaft seal	
21	Retaining ring	DIN 472
22	Retaining ring	DIN 471
23	Compensation disk up 3.4 HP (2.55 kW)	
24	Shaft seal up 3.4 HP (2.55 kW)	
25	O-ring up 3.4 HP (2.55 kW)	
26	Shaft seal	
50	Pump body	
51	Shaft with rotor	
52	Intake cover	
55	Impeller	
57	Suction screw	
58	Extension pump body up 30.32 Inches (770 mm) depth of immersion	
60	Distance liner	
61	Running sleeve	
62	Bearing bush	
63	Distance plate	
64	Woodruff key	DIN 6888
65	Flat head screw	DIN 7991
66	O-ring up 30.32 Inches (770 mm) depth of immersion	
67	O-ring up 30.32 Inches (770 mm) depth of immersion	
69	Splash ring	
70	Serrated lock washer	
72	Socket head cap screw	DIN 912
78	Socket head cap screw up 30.32 Inches (770 mm) depth of immersion	DIN 912
79	Hexagon thin nut	
82	Joining socket	
83	Socket head cap screw	DIN 912
84	Spring washer	DIN 7980
85	O-ring	
86	Screw plug	DIN 908
87	Sealing ring	DIN 7603
88	Woodruff key	
91	Extension shaft up 30.32 Inches (770 mm) depth of immersion	
92	Insert shaft	
93	Shaft clamp 2 x up 30.32 Inches (770 mm) depth of immersion	

10.2 Indications to the spare part order

Spare parts are available from the supplier. Standard commercially available parts are to be purchased in accordance with the model type. The ordering of spare parts should contain the following details:

1. Pumptype

e.g. SFL850S330

2. Pump No.

e.g. 08246520

The date of the construction year is a component of the pumps type number.

3. Voltage, Frequency and Power

Take item 1, 2 and 3 from the nameplate

4. Spare part with item No.

e.g. Intake cover item No. 52

11 Repair Instructions / Replacing shaft clamps and shafts

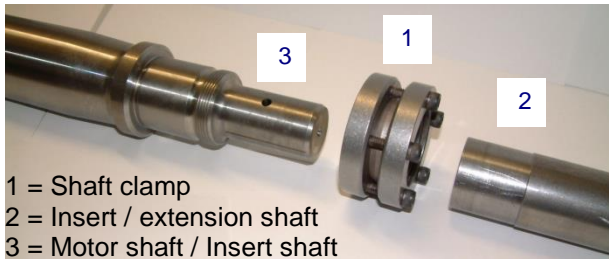

11.1 Dismantling the insert shaft or extension shaft

- Disconnect the submersible pump from the mains both electrically and mechanically.
- Remove pump from system. Secure pump against tipping over, i.e. use ropes to secure pump.
- Set the pump down on the fan cover. Dismantle the pump unit and the extension pump body (if appropriate).



Wear safety gloves!

Risk of injury due to sharp edges on pump components, i.e. impeller blades.

- Loosen the screws on the shaft clamp (1) one after the other.



Do not, under any circumstances, remove the screws completely, **danger of injury!**

- Remove the extension shaft (2) and shaft clamp (1).
- Dismantle the pump body.
- Loosen the screws on the shaft clamp (1) (see above), pull the insert shaft (2) off the motor shaft (3).

11.2 Assembling the insert shaft and motor shaft

ATTENTION

Clean the contact surfaces of the insert shaft (2) (inside) and the motor shaft (3). They must not be lubricated or oiled.

- Set the motor down on the fan cover.
- Position the shaft clamp (1) (use a new shaft clamp) in the centre of the cranked clamping diameter (2) of the insert shaft.
- Insert the motor shaft (3) into the insert shaft (2).
- **Tighten:**
Mark the first screw and tighten all the screws evenly by hand, one after the other in a clockwise direction (not cross-ways).
- Tighten the shaft clamp (\varnothing 24 mm) for SFL550
Use a torque screwdriver to tighten each screw first with 1 ft. lbs. (1.3 Nm) then with 2 ft. lbs. (2.6 Nm) and finally with 3 ft. lbs. (4 Nm) (in a clockwise direction again).
Repeat the last turn with 3 ft. lbs. (4 Nm) 3 times.
- Tighten the shaft clamp (\varnothing 35 mm) for SFL650...1150
Use a torque screwdriver to tighten each screw first with 1.5 ft. lbs. (2 Nm) then with 2.6 ft. lbs. (3.5 Nm) and finally with 3.7 ft. lbs. (5 Nm) (in a clockwise direction again).
Repeat the last turn with 3.7 ft. lbs. (5 Nm) 3 times.
- Mount the pump body.
- In the case of pumps with an extension body, the assembly and tightening of the second shaft clamp is carried out as before.

The remainder of the reassembly process is to be completed in the opposite order of the prior described dismantling process.

ATTENTION

Note torques for the screw connections!

When putting the pump back into use, **make sure the direction of rotation is correct!**

Tightening torques for screwed connections

Thread - \varnothing	M5	M5	M6	M8	M12	M16	M16
Strength classes	4.8	8.8	8.8	8.8	8.8	8.8	
Tightening torque ft.lbs. (Nm)	2.2 (3)	3.3 (4.5) Item.72 SFL550	3.3 (4.5)	15 (20)	22 (30) Item.83 SFL550	44 (60) Item.83	44 (60) Item.79

12 Disposal

When disposing of the pump or the packaging materials the local and national regulation for proper disposal must be complied with.

Prior to its disposal, the pump must be completely drained and decontaminated if necessary.

13 Brinkmann Pumps Inc. Terms and Conditions

The following terms and conditions govern all quotations made by Brinkmann Pumps Inc. („Brinkmann“) and any orders based upon these quotations. No contract term or condition shall be amended, deleted or added without the express written consent of Brinkmann, and Brinkmann hereby rejects any terms set forth in any other writing which are in addition to or different from the terms in this quotation.

These items and conditions and any other terms and conditions delivered in writing by an authorized agent of Brinkmann contemporaneously herewith constitute the complete agreement between Brinkmann and the buyer and supersede all prior oral, written or printed statements of any kind (including any terms and conditions submitted by the buyer and performance or production data from any source whatsoever, including references to accuracy, capacity, and capability of products, all of which are estimates only) made by Brinkmann or the buyer or their respective representatives. No statement, recommendation or assistance given by Brinkmann or its representatives to buyer or its representatives, in connection with the use of any products by buyer, shall constitute a waiver by Brinkmann of any of the provisions hereof or affect Brinkmann's liability, as defined herein. All transactions covered hereby and all terms and conditions of sale shall be governed by the laws of the state of Michigan.

Prices

The products offered in this proposal and the prices quoted are based on our understanding of buyer's requirements; any change in requirements will necessitate a revision in prices quoted. Prices are F.O.B. our dock, Wixom, Michigan, or other location as specified on proposal. Brinkmann's prices do not include sales, use, excise, or similar tax, applicable to the sale or use of the equipment proposed. These taxes shall be paid by the buyer, or in lieu thereof, the buyer shall provide Brinkmann with a tax exemption certificate acceptable to the taxing authorities.

Delays or failure to deliver

Brinkmann shall not be responsible for delay or failure to deliver due to acts of God, or to government action (civil or military), or to prior orders, or to fire, embargo, strike or other labor problems, wrecks, delays in transportation, unusually severe weather or inability to obtain necessary labor or materials from the usual source of supply, or any other circumstances beyond Brinkmann's control.

Brinkmann shall have the right to furnish suitable substitutes for materials which cannot be obtained because of such force majeure.

Installation

Buyer shall install at its own expense, all products covered hereby in accordance with the operating instructions to be furnished to buyer upon request. Unless otherwise stated, no installation services are included in the price indicated.

Limited warranty

Brinkmann warrants to the buyer (but not to any others) for a period of one year from date of shipment that all new parts are free from defects in material and workmanship.

Brinkmann's said warranty shall exist only if buyer gives written notice to Brinkmann within ten days after the first determination that the part is defective and within the aforesaid one year period from the date of shipment and includes in said notice consent to Brinkmann to inspect, at any reasonable time, said part and the machine in which it may be embodied, and if, and only if, Brinkmann determines to its reasonable satisfaction upon said inspection that said part and the machine in which it may be embodied are, and have been, used in accordance with all Brinkmann's instructions as to maintenance and operation set forth in the operating instructions relating to the machine. Brinkmann's warranty is limited to shipping to buyer replacement of any part which is so proven to be defective and in any event shall have **no liability whatsoever for incidental or consequential damage or loss of profit**, including damages resulting from personal injury or death, or damage to, or loss of use of, any property. Brinkmann is not responsible for shipping costs or labor, extends no warranty of any kind for gasket, seals and wear and tear materials. Notwithstanding any provisions of these terms and conditions, **this warranty is the only warranty extended by Brinkmann in connection with any sales of products and is in lieu of all other warranties, express or implied, including warranties of merchantability or fitness for purpose.** No agent, employee or representative of Brinkmann has any authority to bind Brinkmann to any affirmation, representation, or warranty concerning the products that are the subject of this quotation beyond that specifically included in the written quotation. Brinkmann shall have no obligation to install or provide improvements or changes in design adapted by Brinkmann for similar equipment subsequent to acceptance of buyer's order.

Warranties have been discussed and understood by both parties.

Buyer's use and O.S.H.A.

Buyer shall use and require all persons operating the equipment to use all proper and safe operating procedures set forth in operating instructions relating to the equipment and observe all occupational safety health and standards act (O.S.H.A.), American National Standard Institute (ANSI), and state regulations as required and all available, feasible and practical point of operation safety devices consistent with buyer's use of the equipment. Buyer shall not remove or modify, any device, warning sign, operating instructions or work handling tools installed on or attached to the equipment. Buyer shall notify Brinkmann promptly, in writing, and in all events within ten (10) days after its occurrence, of any accident or malfunction involving any equipment which results in injury to or death of persons or damage to property, or the loss of use thereof and buyer shall cooperate fully with Brinkmann in investigation and determining the cause of any such occurrence of malfunction. At Brinkmann's request made at any time, buyer will either at its or Brinkmann's place of business, permit to redesign, remodel or revise the equipment and buyer waives any claims against Brinkmann for buyer's inability to use the equipment during the time that same is out of service for such revision, modification or redesign.

Brinkmann shall not be responsible for any failure to comply which results from the location, operation, design, use or maintenance of the equipment from alternation of the equipment by persons or firms other than Brinkmann, or from an option or accessory to the equipment by persons or firms other than Brinkmann, which was available to the buyer but omitted at the buyer's direction, or from design or instructions furnished by the buyer or its agents. In view of the above, Brinkmann does not make any warranties with respect to O.S.H.A. requirements, including noise; and will not be responsible for fines, penalties, or consequential damages.

Payment terms

Net payment in full of all invoices is due thirty (30) days net, unless stated otherwise in quotation. Any unpaid balance thereafter shall be subject to a service charge of 1.75 % per month or, if illegal, at the highest rate allowed by law. There shall be no extension or change in the time for payment due to delay in installation and/or delays in operation of the equipment caused by damage, warranty service or warranty replacement

of parts. If after Brinkmann's acceptance of buyer's purchase order, buyer requests Brinkmann to delay shipment of the equipment, the purchase price shall become due and owing thirty (30) days after the equipment is ready for shipment.

If buyer fails to pay the purchase price as provided herein and Brinkmann institutes a lawsuit for the collection of said price, buyer agrees to pay Brinkmann's reasonable attorney fees incurred in connection therewith.

Acceptance of orders

Quotations are offered for written acceptance within thirty (30) days from date (unless otherwise stated) but are subject to change without notice at any time before acceptance. If any order contains printed, stamped or other provisions inconsistent or in conflict with the terms and conditions hereof, the terms and conditions hereof shall control, unless otherwise specifically stated by Brinkmann in writing. All clerical errors are subject to correction in favor of either party upon notice of either party. All orders are subject to the credit approval of Brinkmann. An order containing subject matter not within the contemplation of the proposal shall be subject to a further quotation as to price or delivery or both. Modifications, changes, deferred shipments, cancellations or additions will be effective only if accepted by Brinkmann in writing and then only upon terms that will indemnify Brinkmann against all costs and losses.

Title and security agreement

Delivery to carrier shall constitute transfer to the buyer, and all risk of loss or damage in transit shall be borne by the buyer.

By execution of a purchase order, buyer hereby grants to Brinkmann a security interest in the equipment covered by the proposal, and its products and/or proceeds in order to secure the payment of the purchase price thereof and buyer authorizes to file financing statements reflecting this security interest without buyer's signature. Buyer will cooperate with Brinkmann in preparing documents necessary to perfect this security interest.

Proprietary and other materials

This quotation and all drawings, specifications, materials, patterns, and special purpose manufacturing aids which are supplied to buyer by Brinkmann shall be kept in confidence and shall be listed and maintained in suitable condition at the expense of buyer and are to be considered the property of Brinkmann held on consignment by buyer and to be insured while in buyer's possession. Such articles and all copies thereof from any source shall be returned to Brinkmann at

any time upon request and shall not be used for or by any third parties without the express written permission of Brinkmann.

Performance in event of default

In addition to the rights and remedies conferred upon Brinkmann by law, Brinkmann will not be required to proceed with the performance of any order or contract if buyer is in default in the performance of any order or contract with Brinkmann and in case of doubt as to buyer's financial condition, shipments under an order may be suspended or sent sight draft with bill of lading attached and Brinkmann may decline further shipments except for cash before shipment.

Hold harmless/indemnity

Except to the extent of the limited warranty set forth above and Brinkmann's own gross negligence or willful misconduct, buyer hereby:
(1) waives, releases and discharges any and all claims of any and every kind (including but not limited to injury or death of any person or damage to property), which it may have at any time against Brinkmann, its agents or employees, by reason of or arising out of any claimed improper design, specification or manufacture of the equipment sold hereunder, or of any claimed inadequate or insufficient safeguards or safety devices; and (2) covenants to indemnify and hold harmless Brinkmann, its agents and employees of, from and against any and all loss, damage, expense (including attorney's fees), claims, suits or liability which Brinkmann or any of its employees may sustain or incur at any time for or by reason of any injury or death of any person or persons or damage to any property, arising out of any claimed improper design or manufacture of the equipment sold hereunder, or of any claimed inadequate or insufficient safeguards or safety devices.

Electrical equipment

Motors, electrical equipment and wiring on the equipment quoted will be supplied in accordance with the manufacturer's standards. Unless specifically quoted they are not guaranteed to meet ordinances of any local governing body and the responsibility of conforming to any local ordinance is assumed by the buyer.

Inspection and testing, production estimates and performance

All working drawings or other materials provided by Brinkmann are for general information purposes only and may or may not relate to buyer's order or other equipment. Any specifications contained therein are not binding on Brinkmann except as expressly so stated. Brinkmann reserves the right to make, at any time, such changes in detail of design or construction as shall in the sole judgment

of Brinkmann constitute an improvement over former practice. Production data, where given, are based on Brinkmann's careful analysis and understanding of the limits of accuracy, machinability of materials, amount of material to be removed, handling facilities provided, and location points but are nonetheless an estimate only and not guaranteed or warranted. In no event shall Brinkmann be responsible for performance figures supplied by other parties. If by written agreement the equipment is to be subject to acceptance tests before shipment, rejection under this clause must take place prior to shipment.

Returned equipment

In no case is equipment to be returned without first obtaining written permission from Brinkmann. Unless otherwise expressly agreed an order for equivalent value must accompany returned equipment and all such returned equipment will be accepted for credit only after inspection. Equipment returned without good cause and for which no credit is given shall be subject to a restocking charge. Buyer returning equipment must pay transportation charges and bear risks of loss or damage to goods while in transit. Acceptance of returned products by Brinkmann's receiving department shall not bind Brinkmann nor have any force or effect unless acceptance is made by Brinkmann in writing.